



HYDROTAP G5 BCHA60 4-IN-1 CLASSIC TAP WITH CLASSIC MIXER CHROME



BOILING



CHILLED



HOT & AMBIENT

FILTERED

UNFILTERED

Order Code H51623Z00AU

Zip HydroTap Classic 4 in 1 Boiling, Chilled, Filtered water plus Hot and Cold washing up water from two separate taps. The system features a single under bench command centre including full colour interactive touch screen display with pin code protection and customisable settings including 2 boiling water safety modes, 3 energy saving modes including ON/OFF timers and sensor activated 'sleep when it's dark', 'Quiet' mode with automated intelligent fan speed adjustment, SteriTouch® antimicrobial protection impregnated into key water paths for enhanced hygiene, 100% water efficient air cooled technology, and 0.2 micron water filtration. Easy to install integrated ventilation tray included.

Manufacturing Code	H51623Z00AU
Capacity	Commercial
Boiling Cups per hour	160
Chilled Cups per hour	175



Tap	Zip HydroTap CLASSIC Tap (Chrome)
Water Pressure	Min 300kPa - Max 700kPa
Water Connection	1/2" BSP (G1/2)
Water Supply Requirements	Cold
Water Valves	Integrated 500kPa Pressure limiting valve and Dual Check Valve
Power Rating	2.1kW 220-240V 50Hz
Power Supply	1 x 10 Amp socket outlet
Dimensions	W395mm x D464mm x H333mm
Product Approvals	WaterMark, RCM, ARC
Wels Rating	6 Star, 3.0 litres
Warranty	5 years (appliance warranty 36 months plus additional 24 months tank warranty)

Installation Requirements

1. Installation and connection of your Zip HydroTap must be carried out by a qualified person, observing national and local regulations. 2. You will require suitable mains electrical and drinking water connections, plus waste water drainage all within 1.5 metres of the product. 3. HydroTap is air-cooled so discrete cabinetry cut-outs are required for ventilation. 4. Installation on most bench tops is straightforward however some stone bench tops may require a specialised cutting service. 5. If you live in a hard water area, we recommend installation of a Zip scale filtration kit. 6. Installation by Zip Professional Service can be arranged with a phone call or through www.zipwater.com

Installation Detail



Ventilation requirements contact your local service provider if ventilation is not suitable

Clearance envelope

Position the Tap and the Command Centre as close together as possible.

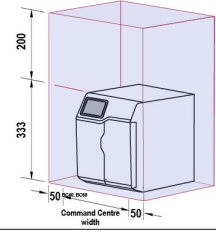

Vent tray (kit no. 93540)

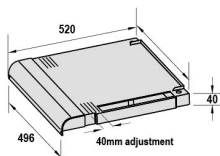

HydroTap Tap options

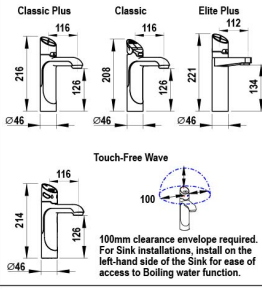

Tap Positioning

Position the Tap to dispense into the sink, allowing clearance for a cup or teapot. Alternatively, mount the HydroTap Tap on a Font (available as an accessory).
 ○35mm hole for HydroTap Tap ○35mm hole for Mixer Tap

Mixer Tap options

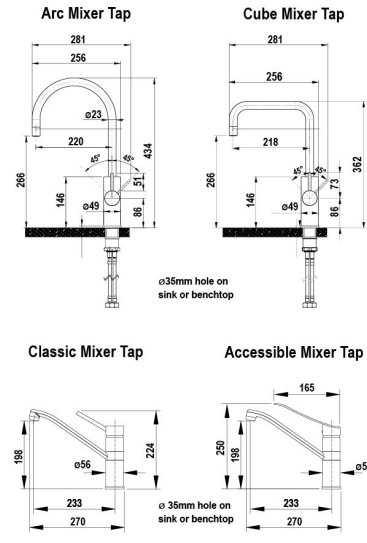

Detail A. Air inlet grille

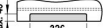

Detail B. Vent Tray air outlet

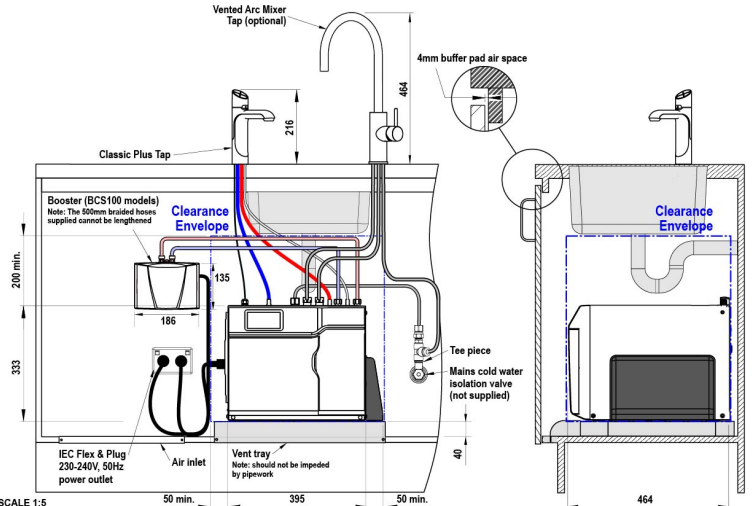

SCALE 1:5
 ALL DIMENSIONS IN MM UNLESS OTHERWISE SPECIFIED. INSTALLATION DIAGRAMS ARE FOR ILLUSTRATIVE PURPOSES ONLY. HOSES ARE NOT SHOWN TO SCALE AND CANNOT BE LENGTHENED.

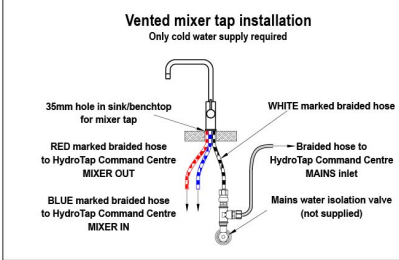

HydroTap G5
BC40 H, BC60 H, BC100 H

shown with "Classic Plus" Tap and Arc Mixer Tap (V)